

CYRIL TYP 08

Art.-Nr.

262796

	800	1/4
	400	
	350	
	mm	ZO



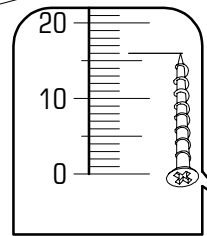
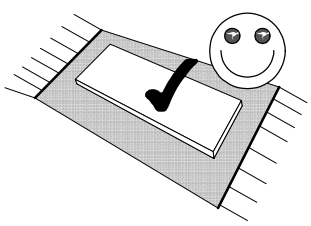
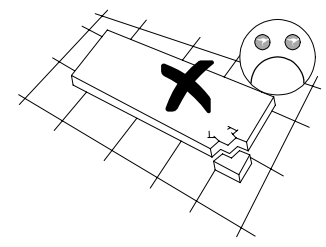
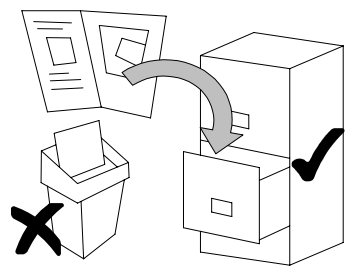
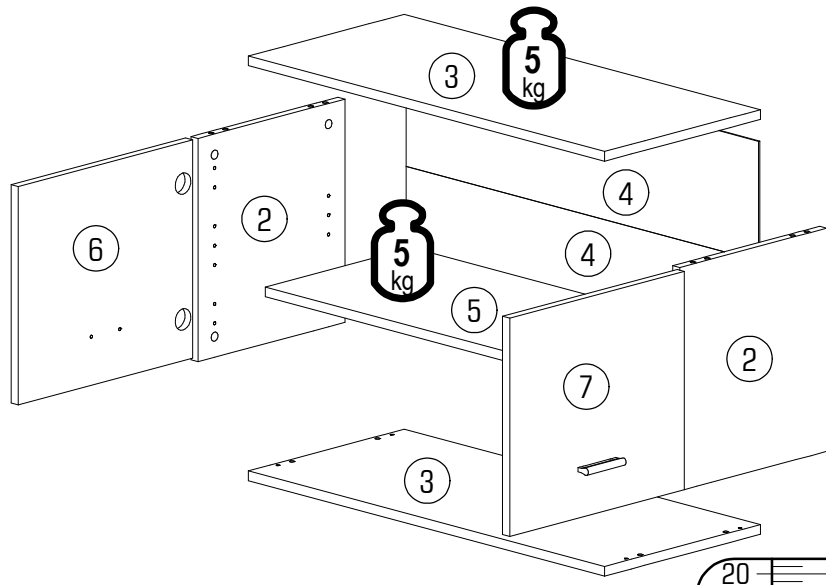
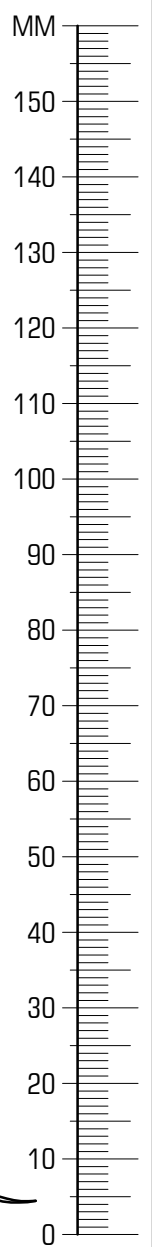
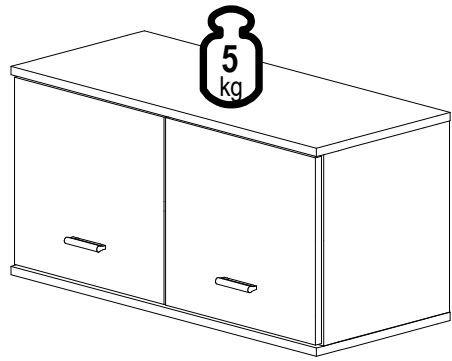

	 40min		 ≤ 0,5 kg	 3m	 PZ 2	 300 mm	
--	-----------	--	--------------	--------	----------	------------	--

ID EE	ID			
17203	②	368*330*16	2x	1/1
17077	③	800*350*16	2x	1/1
17204	④	197*792*3	2x	1/1
17080	⑤	766*329*16	1x	1/1
17205	⑥	360*392*16	1x	1/1
17206	⑦	360*392*16	1x	1/1

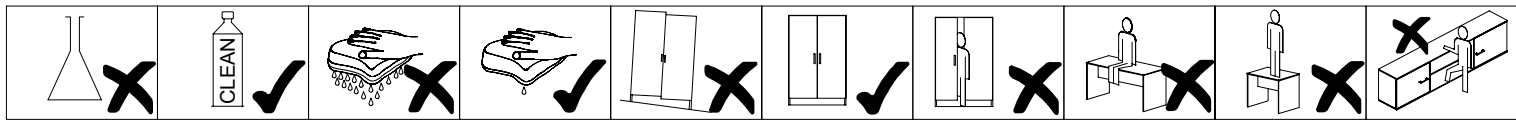

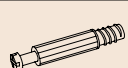

	21102.00		27000.00		70013.01		70021.01		35101.01		22430.00		22243.00		24101.00		32314.01
A	50x	B	8x	C	8x	D	8x	E	4x	F	4x	G	12x	H	2x	J	2x
	22206.00		31000.01		8402.03		22601.00		36002.07		36002.07						
K	8x	L	2x	M	2x	N	2x	P	4x	R	4x	S	4x				



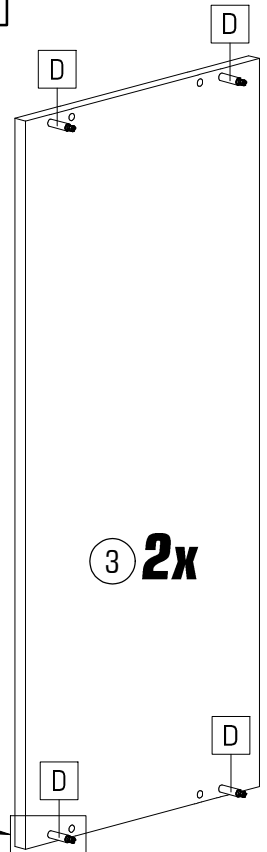
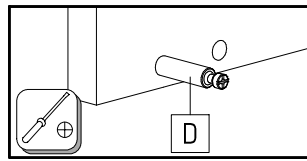
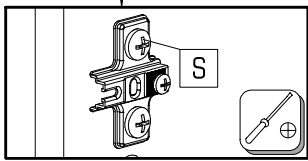
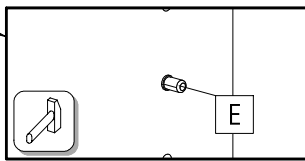
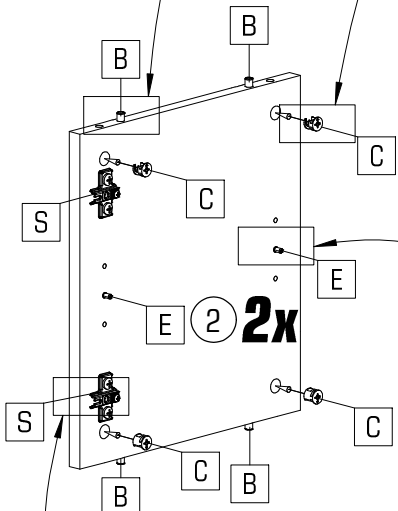
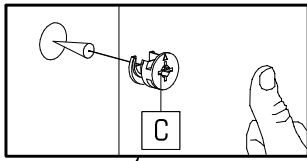
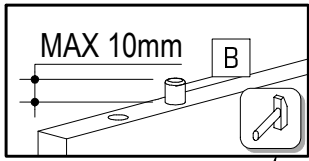
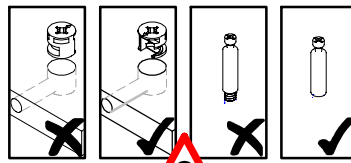

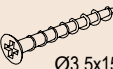
				
B 8x	C 8x	D 8x	E 4x	S 4x

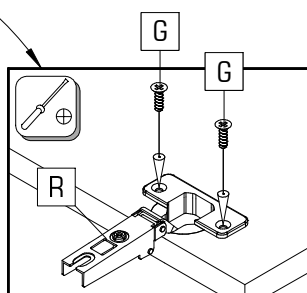
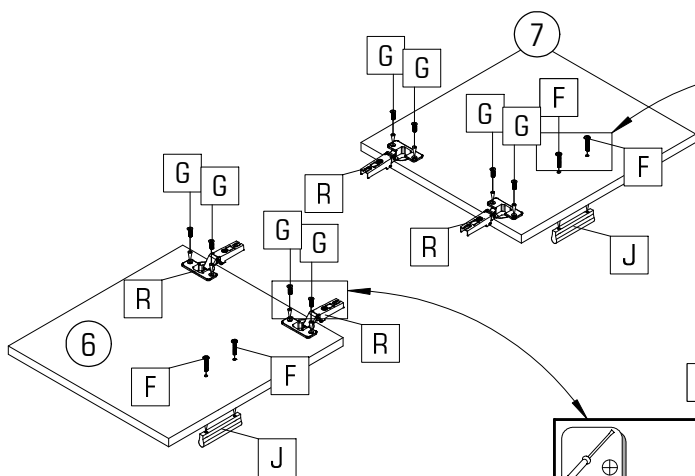
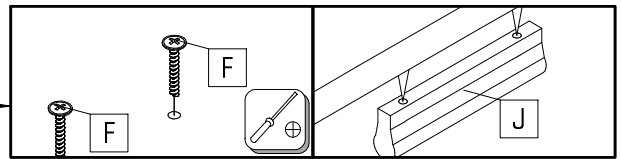
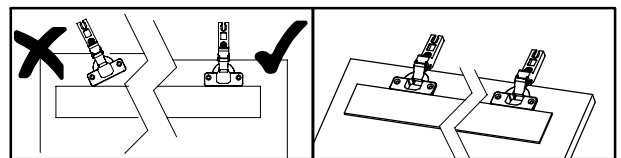

			
F 4x	G 8x	J 2x	R 4x

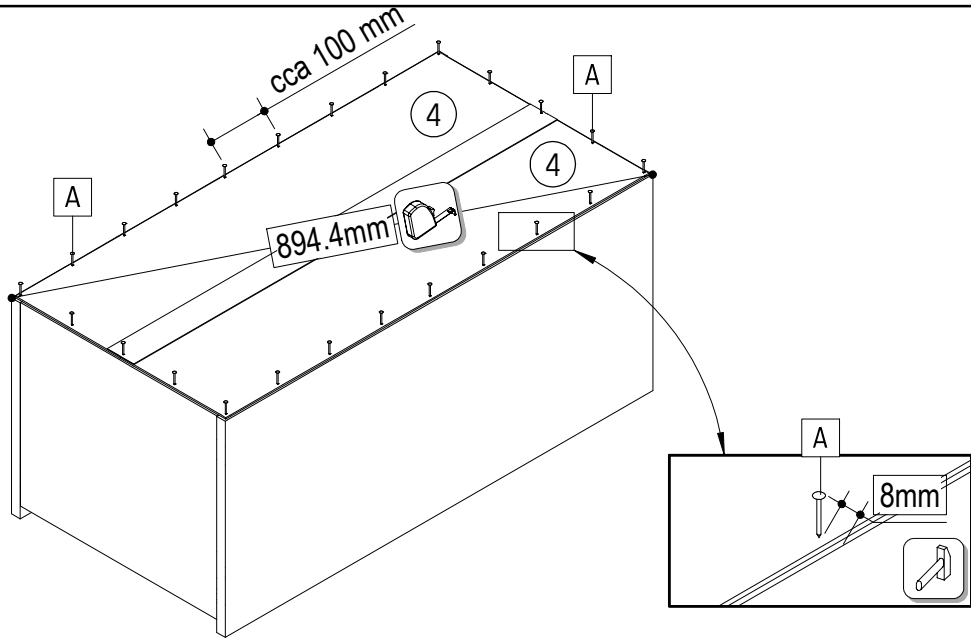
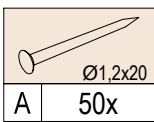
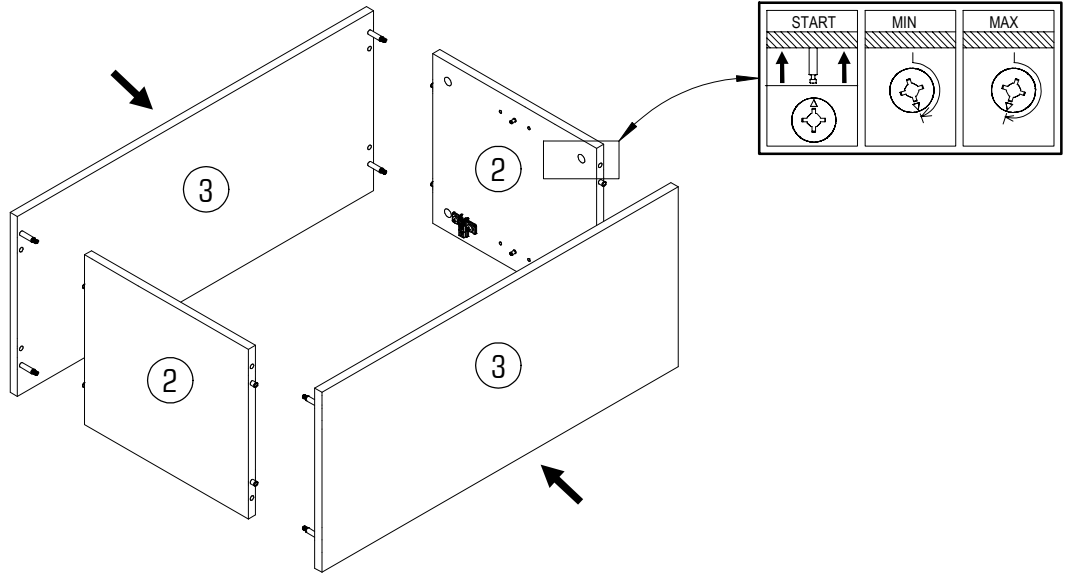

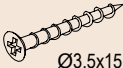
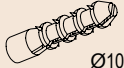
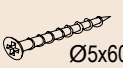

			
G 4x	H 2x	L 2x	M 2x

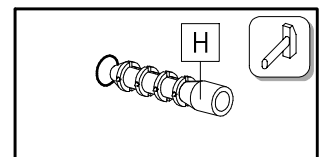
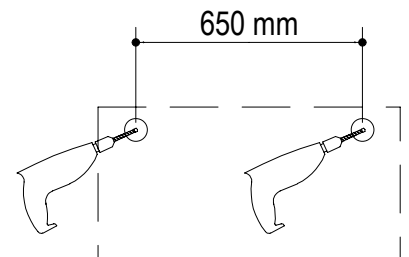
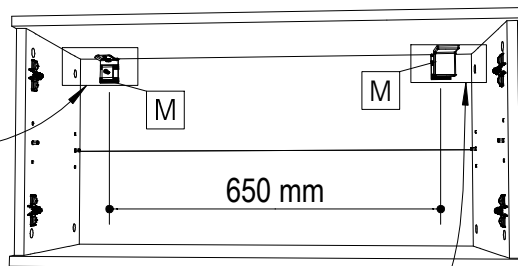
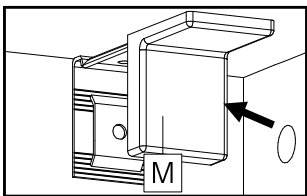
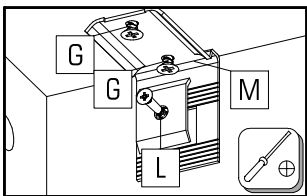
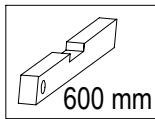

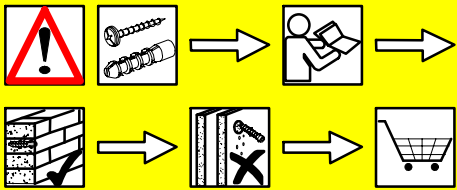

Vigyázat! Szerelés előtt a falfelület feltétlenül vizsgálja meg. A mellékelt univerzális tiplé kizárólag stabil falazathoz használható mint például beton/tégla. A fal tiplé nem használható könnyű építőkövekhez, üreg tégla, gipszkarton lapokhoz vagy más fávázás építményekhez. Ezekhez a falfelületekhez csak speciális tiplék használhatóak, melyek szaküzletekben (barkácsruházakban) beszerezhetőek. Fentiek figyelmen kívül hagyása esetén a gyártó/kereskedő vagy forgalmazó nem vállal felelősséget.

Upozornenie! Pevnosť steny sa musí pred montážou bezpodmienečne skontrolovať. Univerzálne hmožďenky, ktoré sú obsiahnuté v balení používajte jedine pre pevné murivo ako je beton/tiehla. Hmožďenky sa nesmú používať v prípade ľahkého staveného muriva, dutina tiehla, u sádrokartónových dosiek alebo iných konštrukcií rámu. U týchto murív je nutné použiť špeciálne hmožďenky! Tieto je možné dostať v špeciálnych predajniach so stavebným materiálom (stavebniny). Pri nedodržaní pokynov nepreberajú výrobcovia/predajci a dodávateľa zodpovednosť za vzniknuté škody.

Upozornění! Před montáží je nutné zkontrolovat stav stěny. Přiložené univerzální hmoždinky jsou určeny pouze k použití pro pevné zdivo jako beton/cihly. Hmoždinky do zdi se nesmí používat u dutinová cihla, zdiva jako pórovitý stavební kámen, sádrokartónová deska nebo jiný měkký materiál. U těchto zdív jsou nutné použít speciální hmoždinky! Jsou k dostání v speciálních prodejnách se stavebním materiálem. Při nedodržení těchto pokynů výrobce/prodejce a dovezce neručí za způsobené škody.

Pażnja! Prije montaže obvezno provjerite svojstvo zida. Priložene univerzalne tiplje namijenjene su isključivo za masivne zidove od betona/opeke. Tiplje za masivne zidove ne smiju se koristiti za zidove kao npr šupljina opeka laki sastavni elementi, gips-kartonske ploče ili drugi modularni načini gradnje. Za te zidove potrebne su eventualno specijalne tiplje! Iste su dostupne u specijaliziranim trgovinama građevinskim materijalom. U slučaju nepridržavanja prethodno navedenih napomena, proizvođač/trgovac i uvoznik ne preuzimaju odgovornost!

Prudent! Zidul trebuie examinat înainte de asamblare prizele de perete sunt adecvate numai pentru utilizarea în zidărie fermă, cum ar fi betonul bloc sau cărămidă. Nu folosiți zidăria zidurilor de perete, cum ar fi cărămida goală, blocul ușor, suprafețe cum ar fi gips-carton sau altă încastrare sisteme. Dacă este cazul, trebuie folosite anumite prize de perete! Acestea sunt disponibile la un magazin specializat (magazin de hardware) . În caz de nerespectare, producătorul / vânzătorul cu amănuntul sau importatorul nu își asumă răspunderea.

Achtung! Die Wandbeschaffenheit ist vor der Montage unbedingt zu prüfen. Die beigelegten Universaldübel sind ausschließlich nur zur Verwendung für festes Mauerwerk wie Beton/Ziegel. Die Mauerdübel dürfen nicht bei Mauerwerk wie Hohlraumziegel, Leichtbausteinen, Gipskartonplatte oder anderer Rahmenbauweise verwendet werden. Bei diesen Mauerwerken sind gegebenenfalls Spezialdübel zu verwenden! Diese sind in einem Fachgeschäft (Baumarkt) erhältlich. Bei Nichteinhaltung wird seitens Produzenten/Händler und Importeur keine Haftung übernommen.

Uwaga! Ścianę należy sprawdzić przed montażem. Dołączone uniwersalne kolki rozporowe są odpowiednie tylko do stosowania w mocnych murach, takich jak beton lub cegła. Nie rób za pomocą kółków rozporowych murowanych, takich jak pustak, lekka kostka, powierzchnie takie jak płyty gipsowo-kartonowe lub inne systemy ram. Jeśli dotyczy, muszą to być określone kolki rozporowe być użytych! Są one dostępne w specjalistycznym sklepie (sklepie ze sprzętem). W przypadku niezgodności, producent / sprzedawca lub importer nie ponoszą odpowiedzialności.

