

DAWSON



	1100	1/4
	430	
	580	
	mm	

	60min		PZ2	0,5 kg	3m	4
--	-------	--	-----	--------	----	---



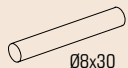

ID	ID			
15726	②	394*576*16	2x	1/1
15727	③	150*580*16	2x	1/1
15728	④	1100*580*16	1x	1/1
15729	⑤	836*114*16	1x	1/1
15730	⑥	840*580*16	1x	1/1
15731	⑦	264*576*16	1x	1/1
15732	⑧	264*576*16	1x	1/1
15733	⑨	804*164*16	1x	1/1
15734	⑩	798*150*16	1x	1/1
14054	⑪	400*120*16	1x	1/1
08715	⑫	746*100*16	1x	1/1
14055	⑬	400*120*16	1x	1/1
15735	⑭	406*756*2,5	1x	1/1

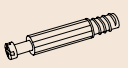
	22243.00 Ø3,5x15	22244.01 Ø3,5x16	22300.00 Ø7x50	22705.00 Ø6,3x8	22800.01 4	27000.00 Ø8x30	30091.00	50553.00	70013.01 Ø15x13								
A	8x	B	6x	C	14x	D	8x	E	1x	F	18x	G	8x	H	2x	J	18x
	70021.01		33008.00		33008.00		33008.00		33008.00								
K	18x	L	14x	M	1x	N	1x	P	1x	Q	1x						

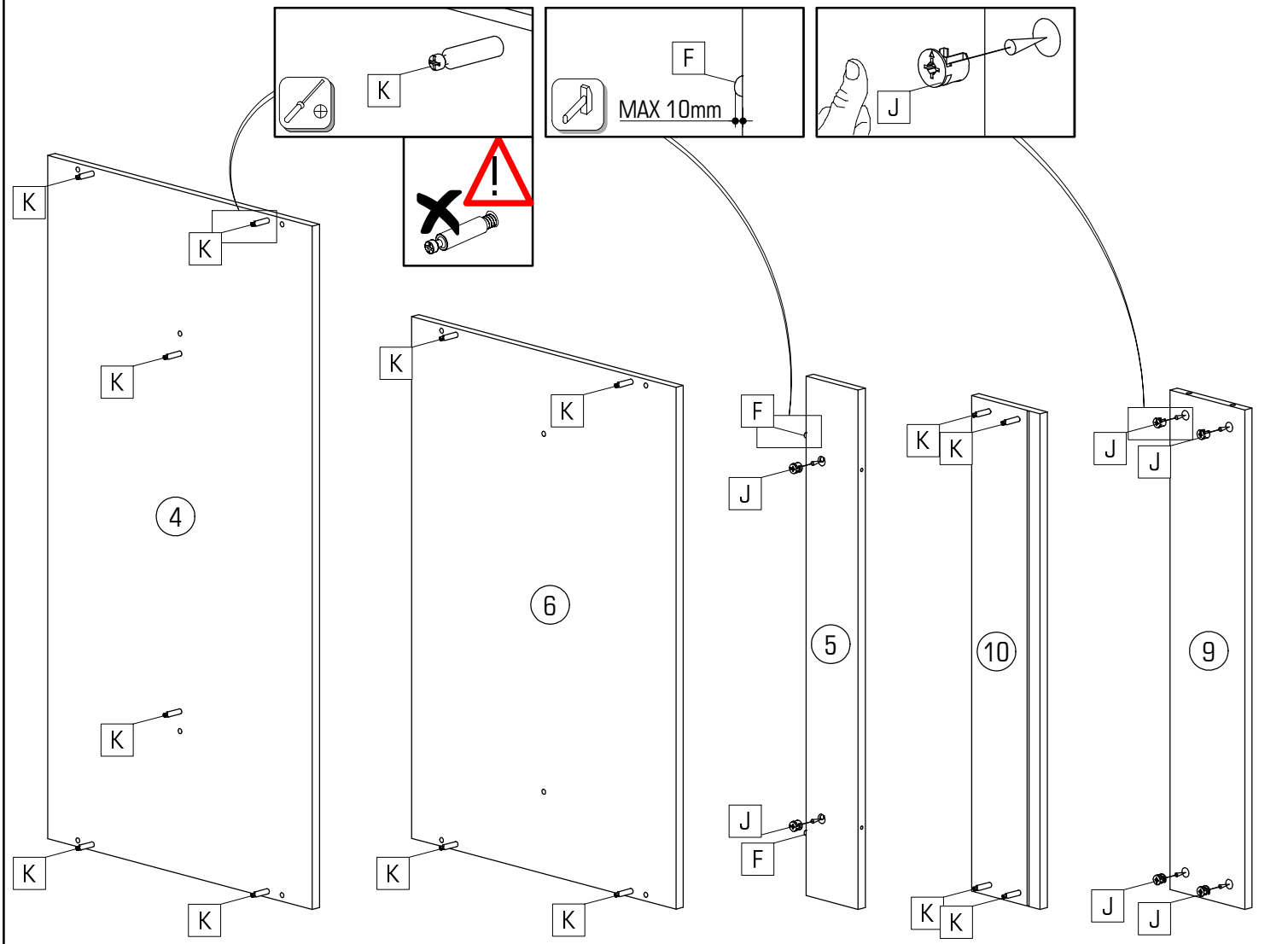
✓	✗	✓	✗	✓	✗	✓	✗	✗	✗

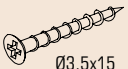

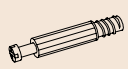
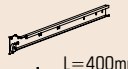
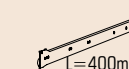

		
Ø8x30	Ø15x13	
F 2x	J 6x	K 14x

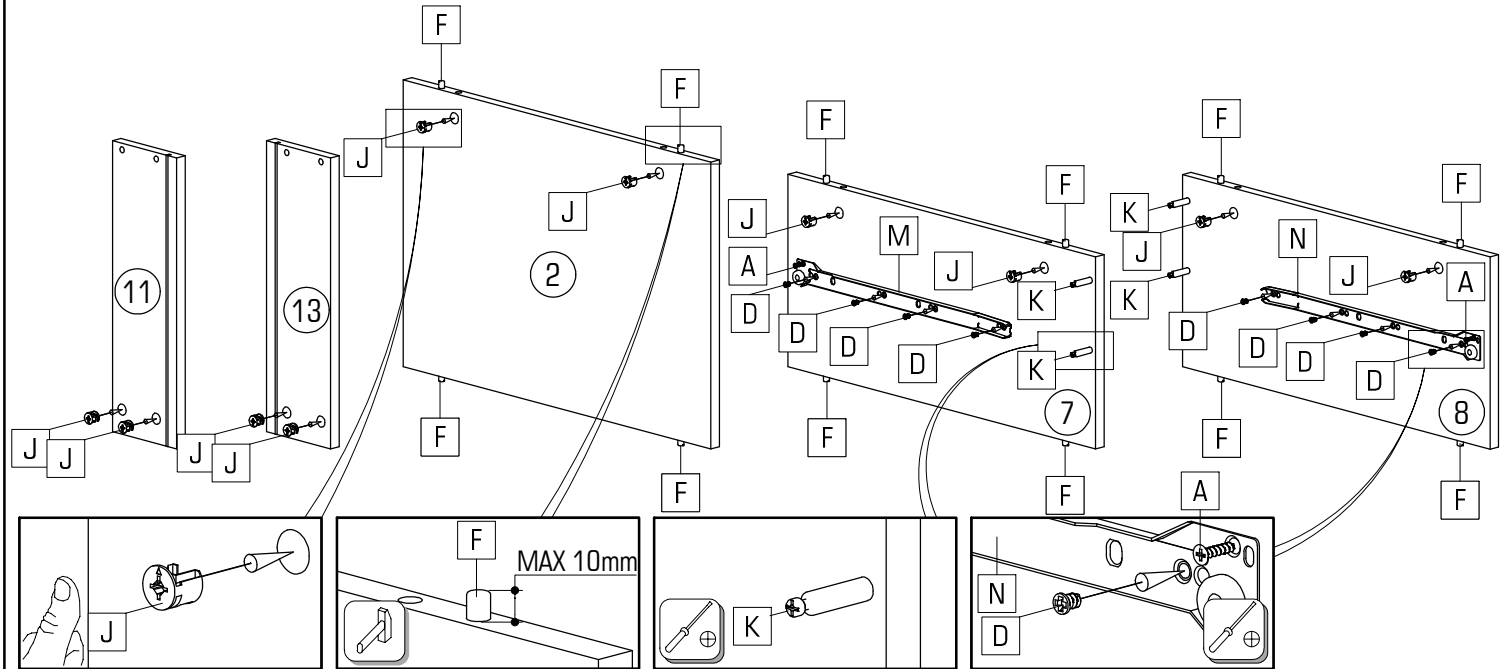

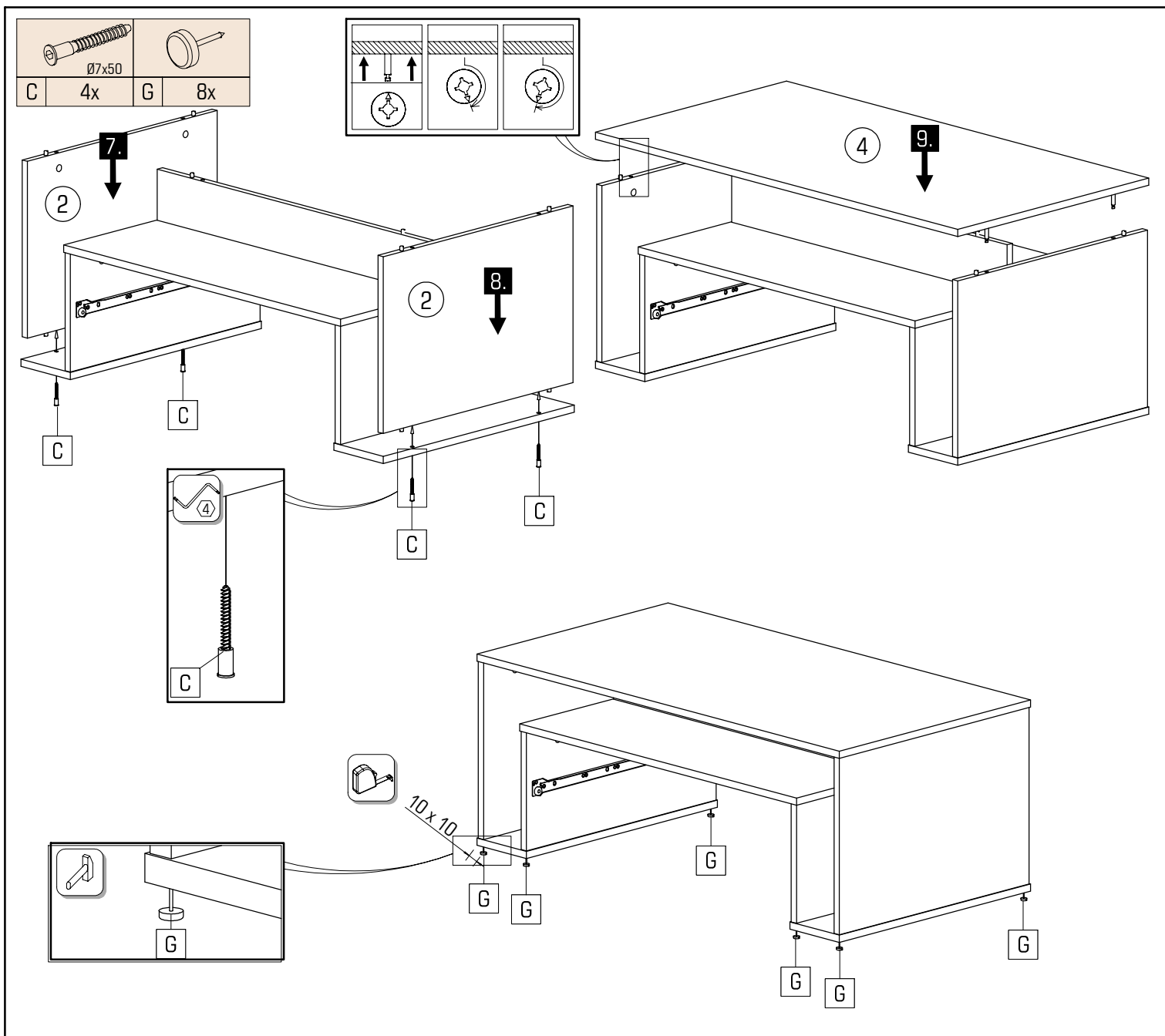
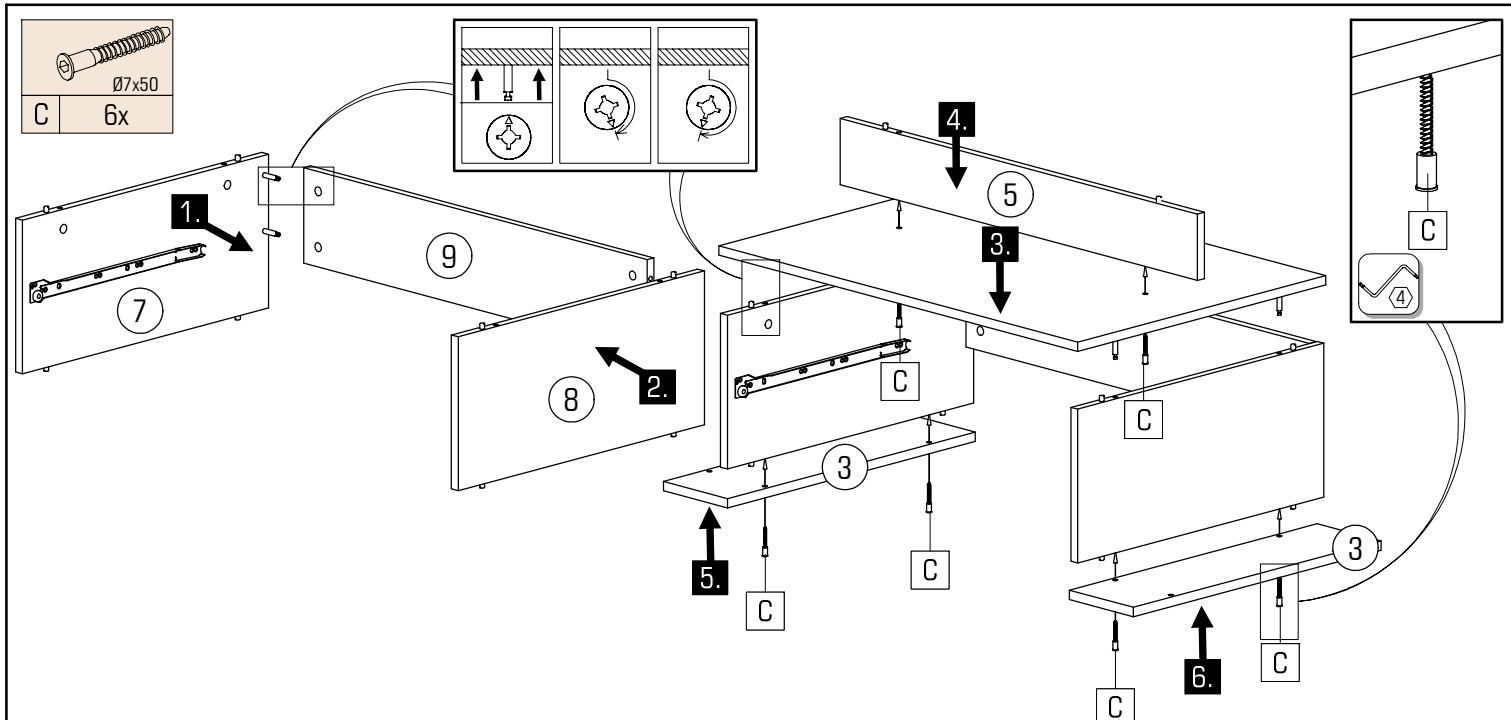
						
Ø3,5x15	Ø6,3x8	Ø8x30	Ø15x13		L=400mm	L=400mm
A 2x	D 8x	F 16x	J 12x	K 4x	M 1x	N 1x

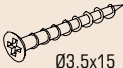
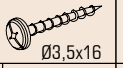

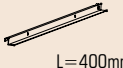
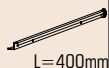

						
A	B	C	H	L	P	Q
6x	6x	4x	2x	14x	1x	1x

