

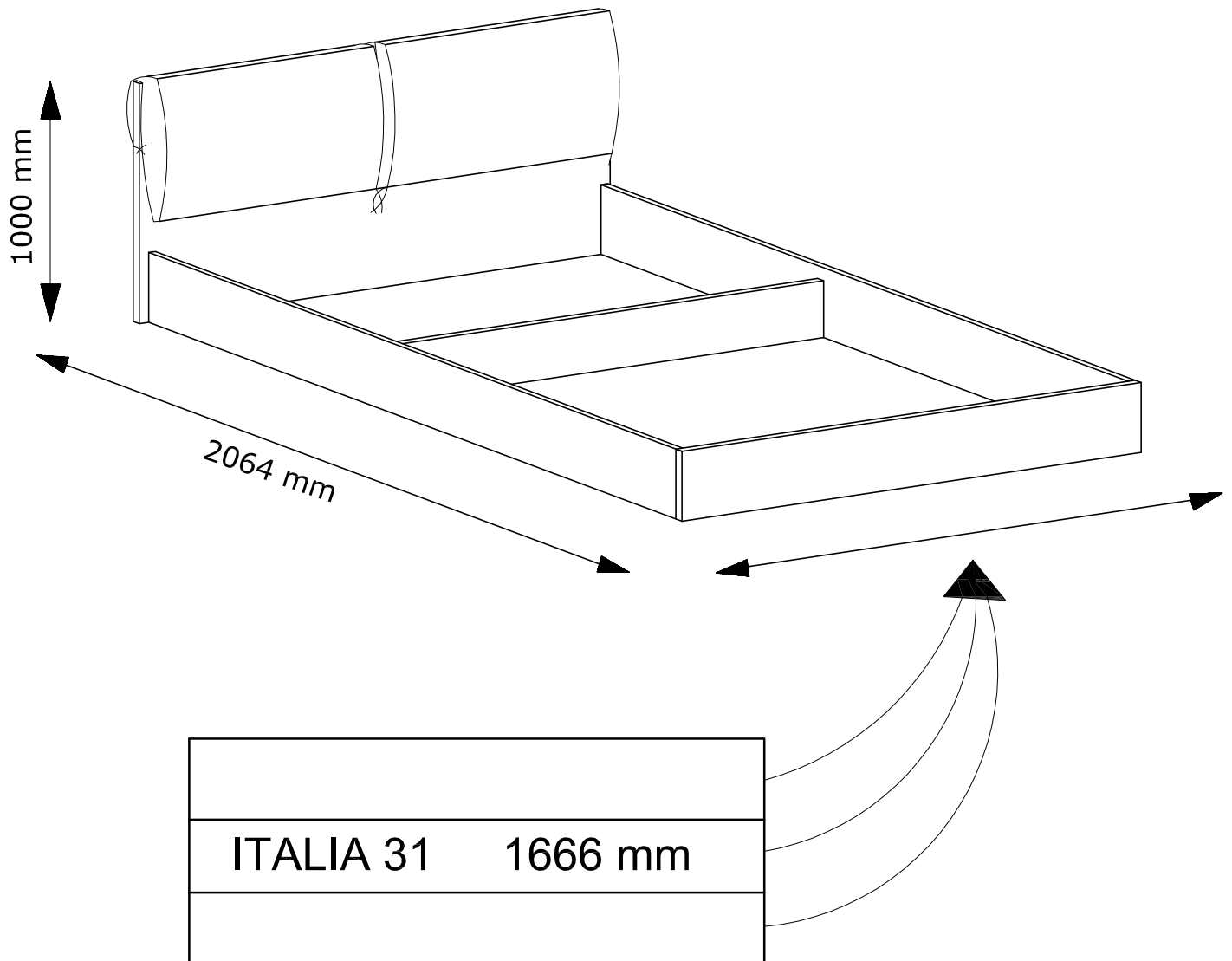

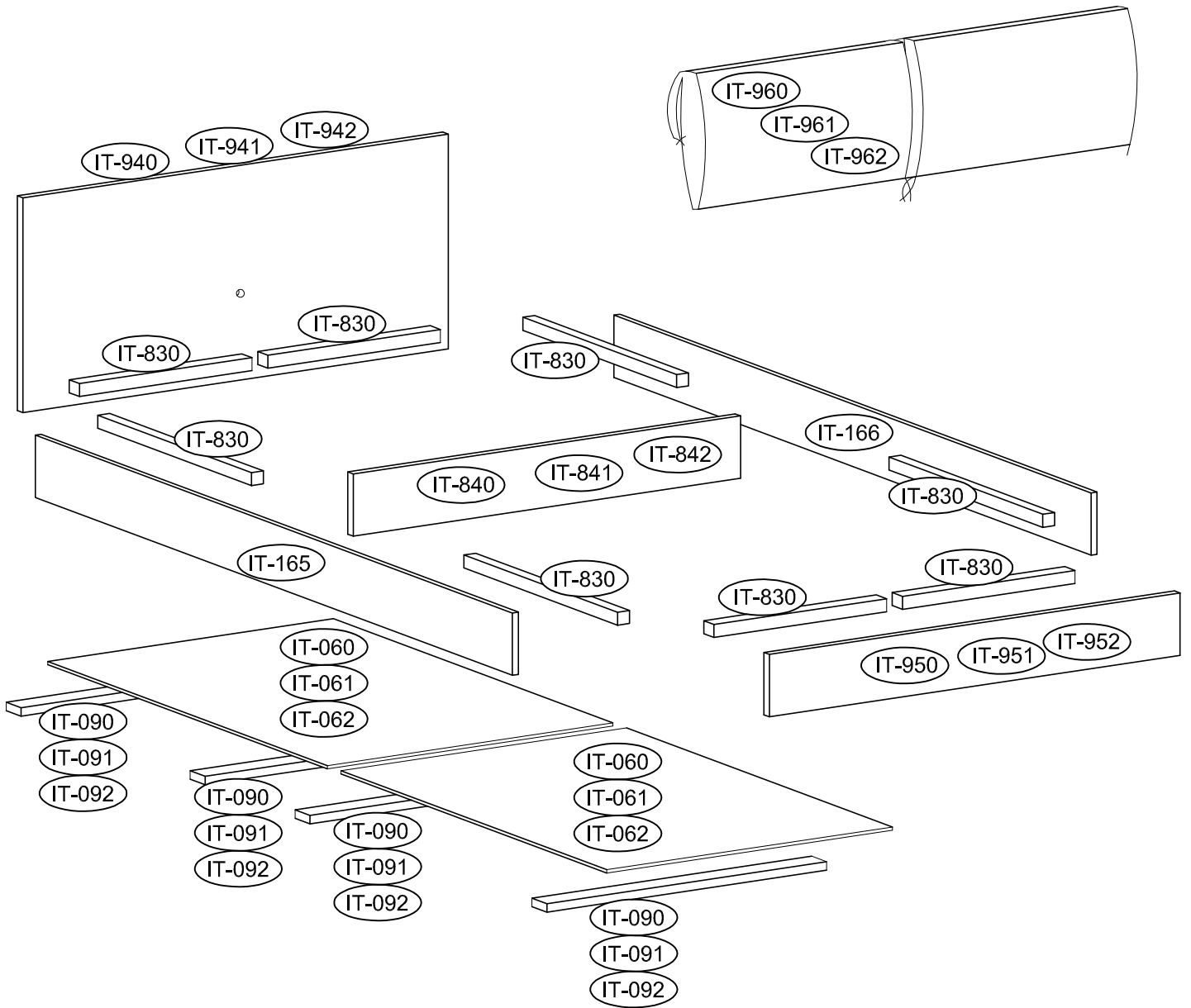



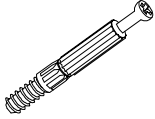

ITALIA IT-M31 POSTEL' 160x200

Montážny návod

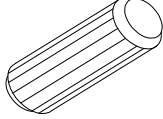
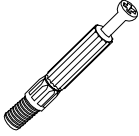

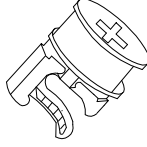
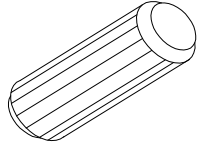
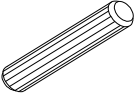
Instrukcja montażu
Montageanleitung
Instructions D'assemblage
Assembly instructions

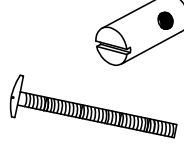

 A-4	 Ø15x16mm B-4	 PS-2	 Ø8x30mm D-74
 E-4	 Ø4.0x45mm M-40	 Ø15x22mm BB-4	 Ø10x35mm DB-8
 Ø8x50mm DD-12	 GW-70	 ML-4	 N-2

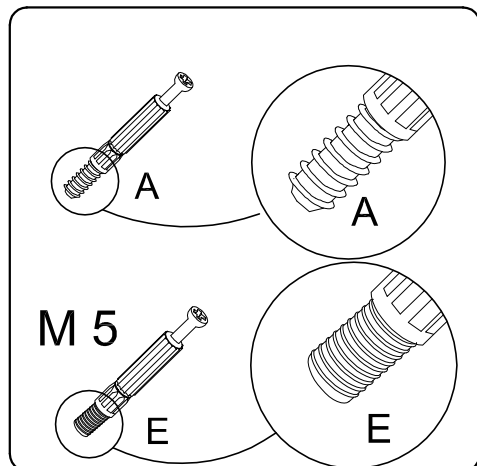

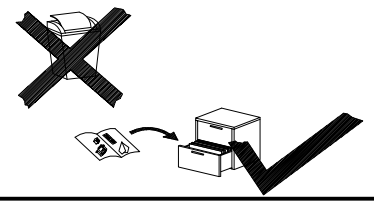
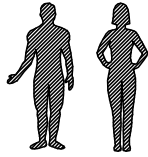
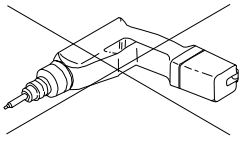

SK: DÔLEŽITÉ INFORMÁCIE!

Pred samotnou montážou a použitím výrobku si pozorne prečítajte návod na montáž.

GB: IMPORTANT INFORMATION!

Please read the entire manual carefully before starting to assemble and/or using product.
Follow the manual thoroughly and keep it for further reference.

SK: NEBEZPEČIE PREVRÁTENIA:

Tento výrobok musí byť pripavený k stene za pomoci priložených úchytiak, aby sa predišlo zraneniam v prípade jeho prevrátania.
Balenie obsahuje skrutky na pripavenie úchytiak k výrobku.
Prosíme Vás, aby ste si overili v špecializovanej predajni, ktorý typ skrutiek/hmoždín je vhodný pre daný typ steny/múru.

GB: ANTI-TOPPLE WARNING!

This product has to be permanently fixed to the wall with the bracket(s) included, to avoid fatal injury in case it topples over.
The pack only contains screw for fastening the anti-topple bracket(s) itself to the product.
Please contact your DIY or hardware store for advice on the correct type of screw/raw plugs for your type of wall.

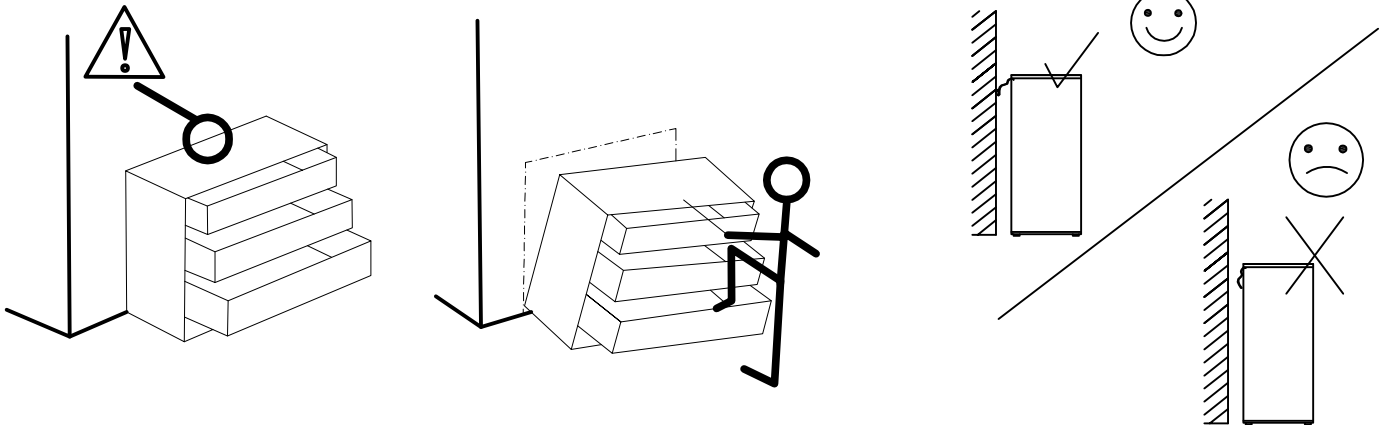

SK: AKO PREDÍŠŤ POŠKODENIAM PRI MONTÁŽI!

Aby ste pri montáži predišli poškodeniam a škrabancom, montujte výrobok na mäkkej podložke (napr. koberci alebo deke)

GB: WARNING TO AVOID SCRATCHES!

In order to avoid scratching this furniture should be assembled on a soft layer- could be a rug.

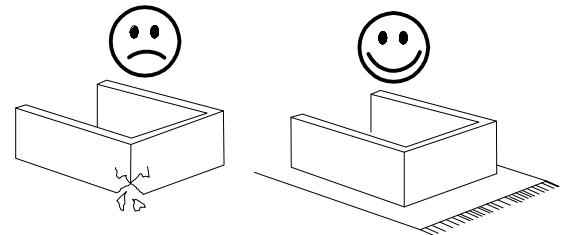

SK: ČISTENIE DREVENÝCH VÝROBKOV ALEBO VÝROBKOV S LAMINÁTOVÝM POVRCHOM!

Čistite mäkkou vlhkou handričkou, použite len vodu alebo jemné čistiace prostriedky.
Následne utrite mäkkou a suchou handričkou.

GB: GENERAL INSTRUCTIONS FOR FURNITURE MADE OF WOOD OR WOOD COMPOSITES SUCH AS MELAMINE, LAMINATE OR VENEER SURFACES!

Wipe clean with a damp cloth
Use only water or a gentle detergent. Wipe dry with a clean cloth.

SK: DÔLEŽITE!

Ak boli pri montáži akékoľvek skrutky, je potrebné ich po 2 týždňoch všetky opäť dotiahnuť.
Následne kontrolujte každé 3 mesiace, či sú všetky skrutky pevne dotiahnuté.

GB: IMPORTANT:

It is important that any product which is assembled using and kind of screw is re-tightened 2 week after assembly, and over every 3 months - in order to assure stability through-out the lifespan of the product.

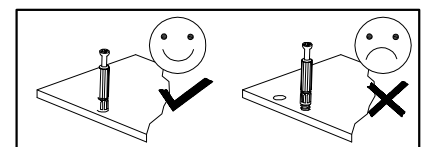

1.

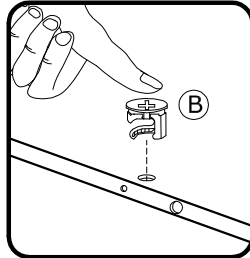
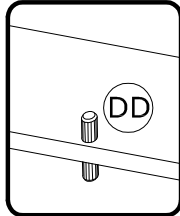
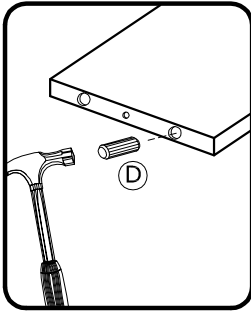
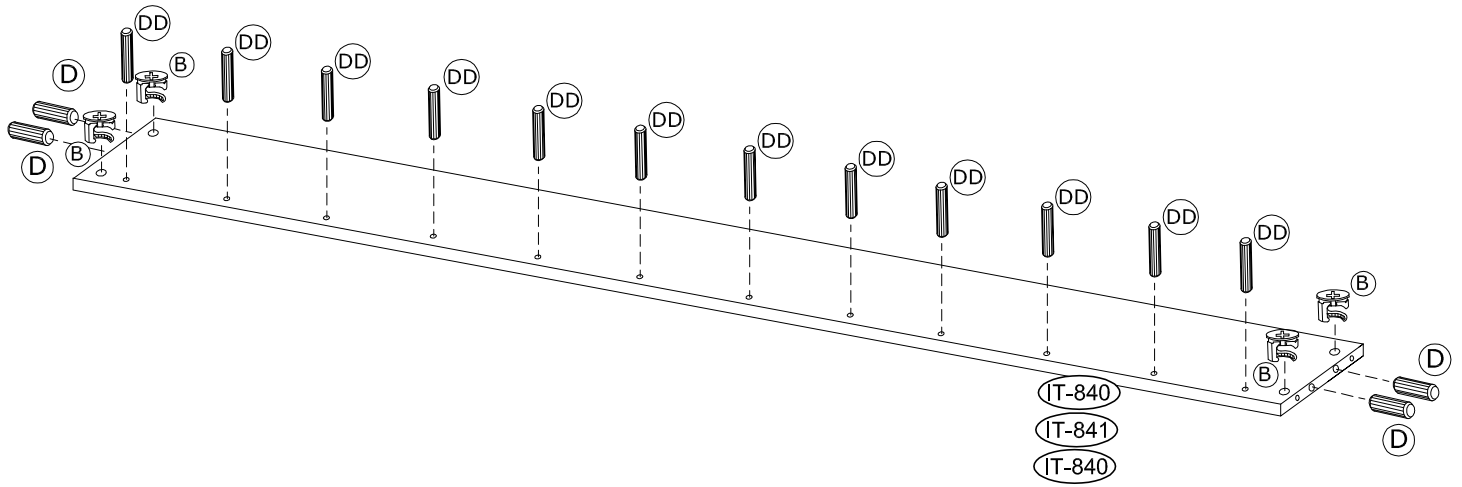

2.

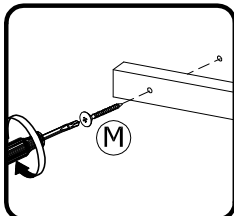
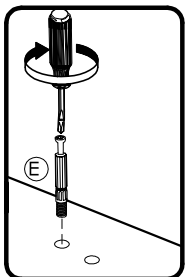
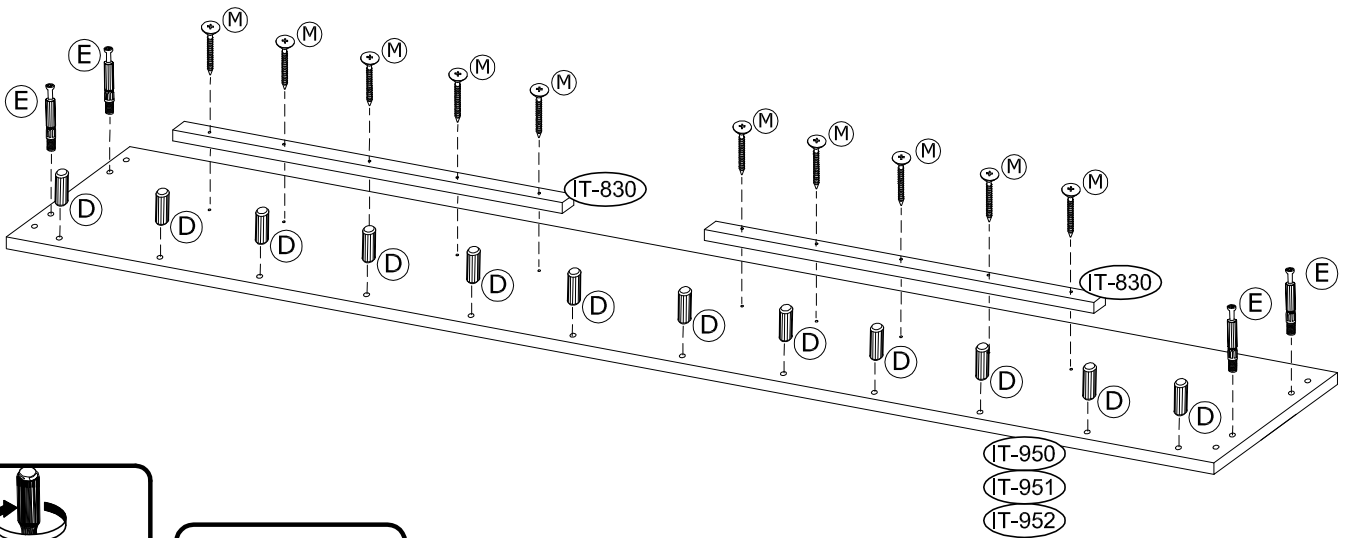

3.



x2

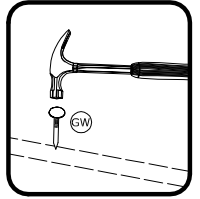
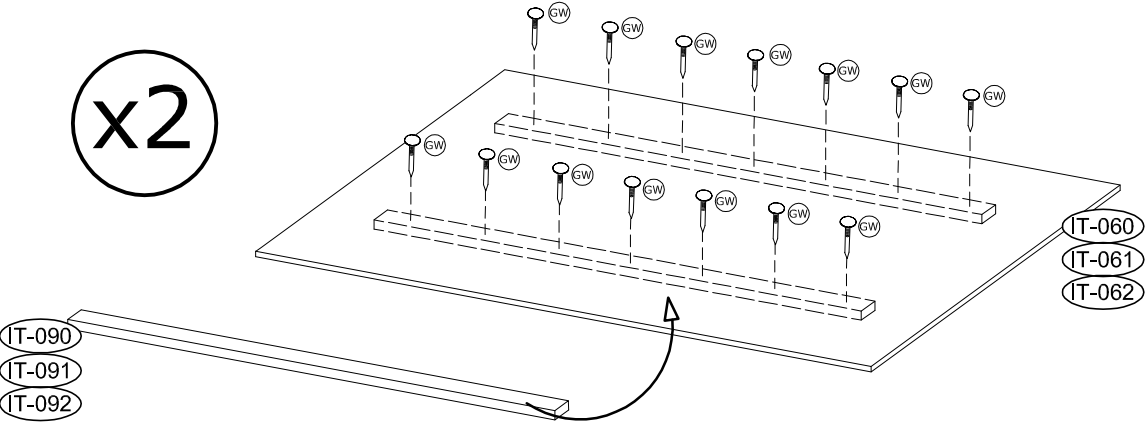

4.

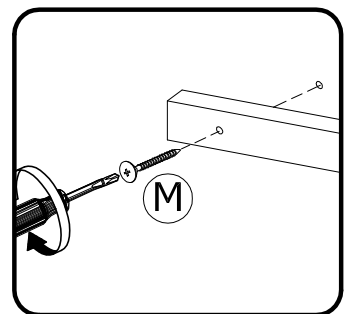
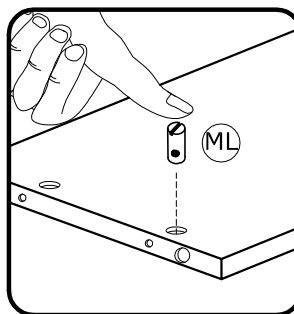
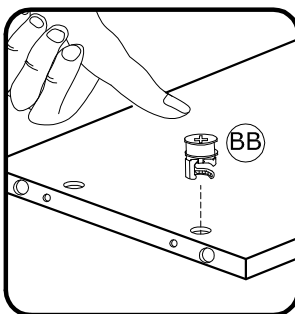
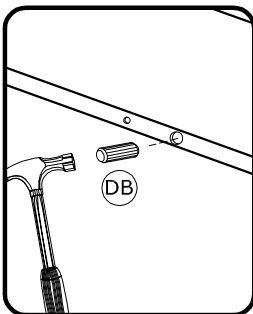
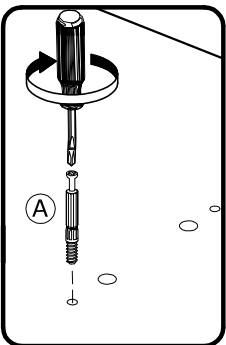
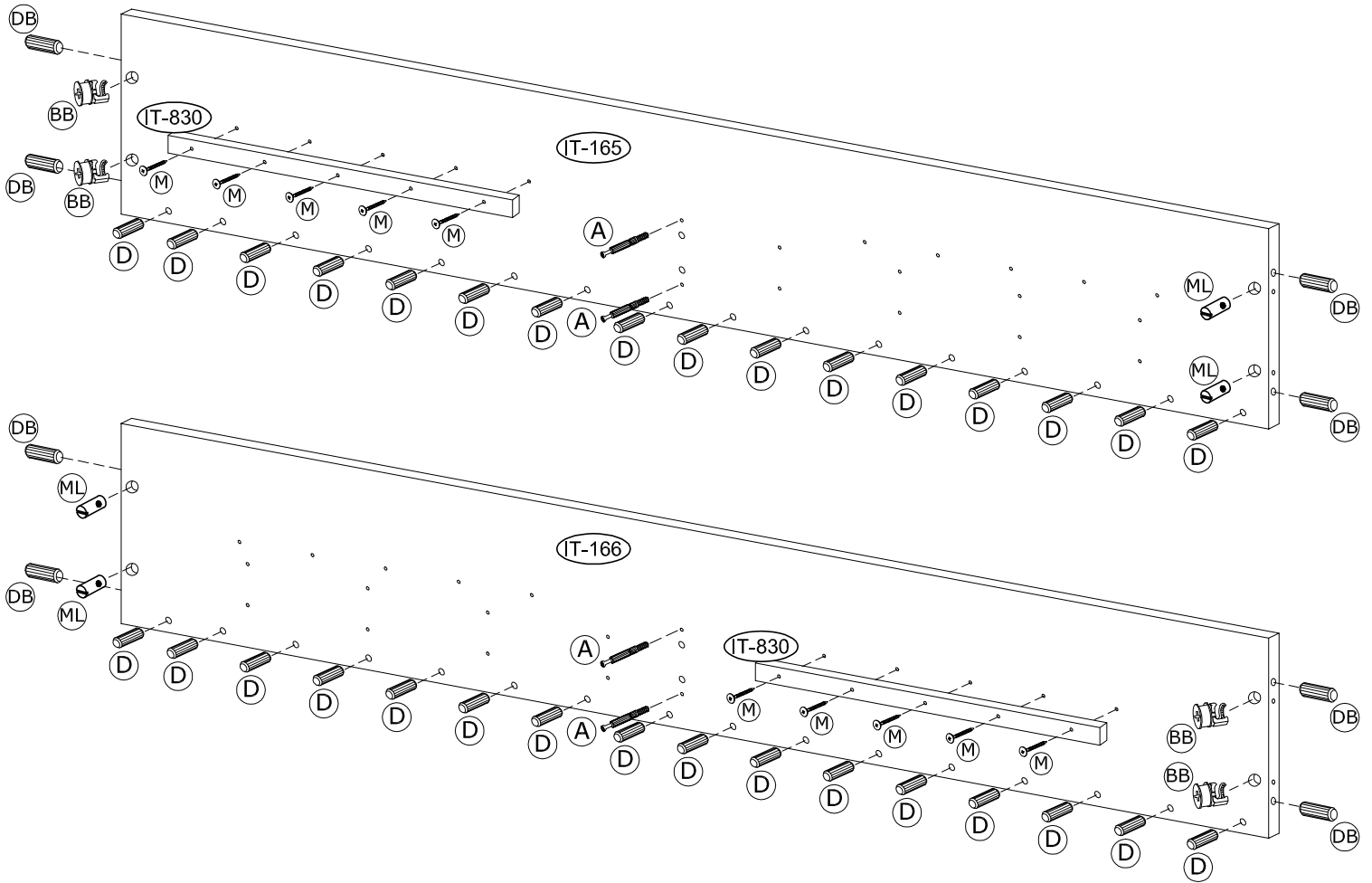
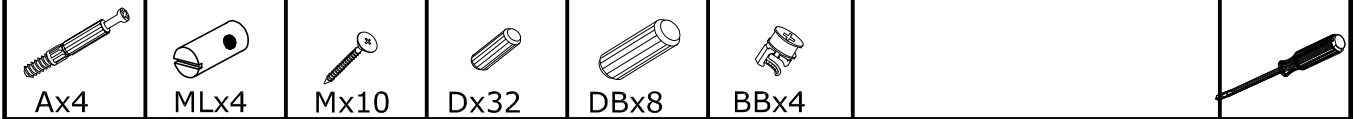

5.

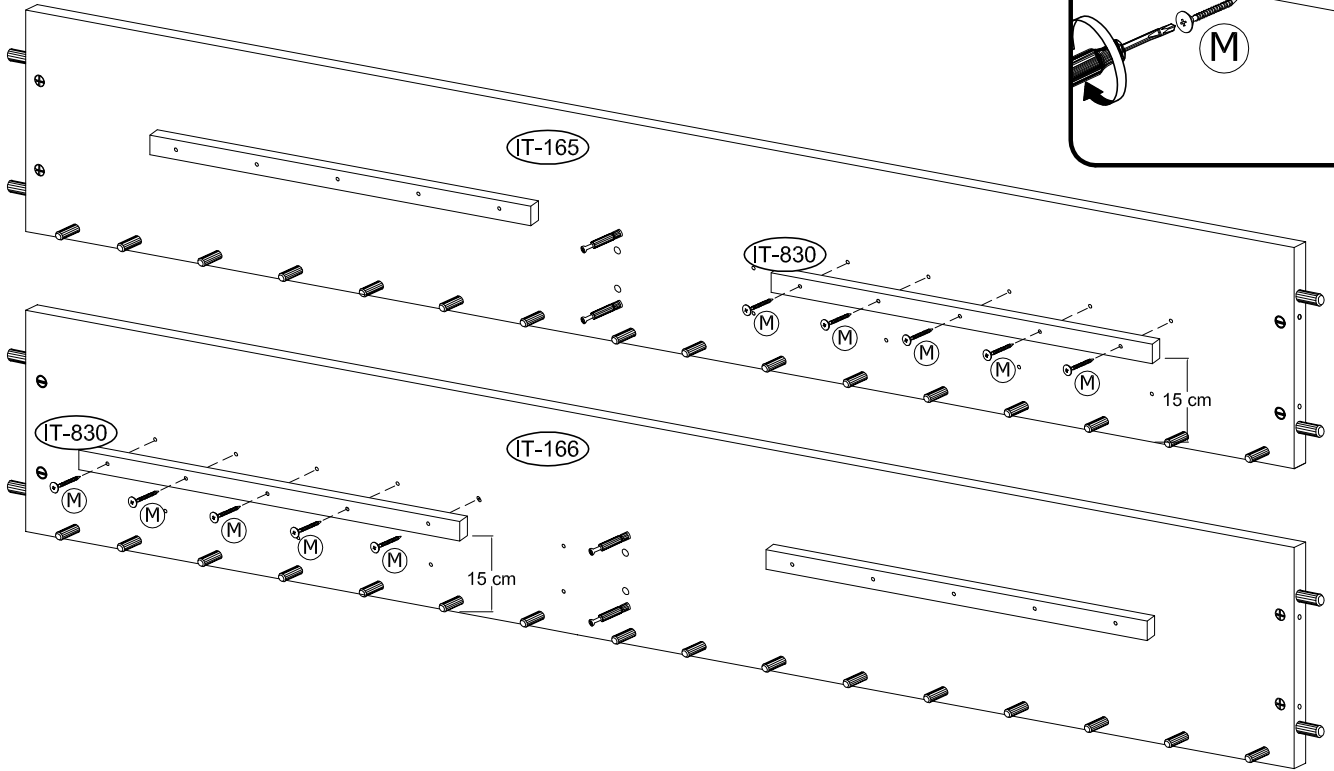
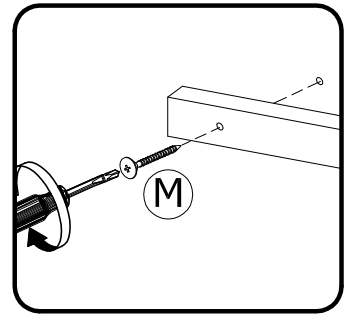
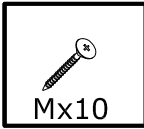

6.

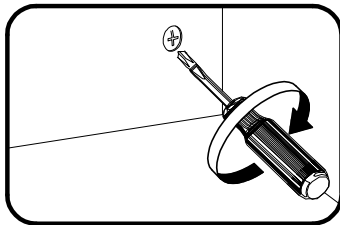
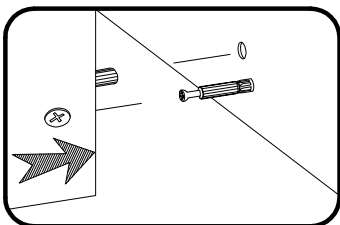
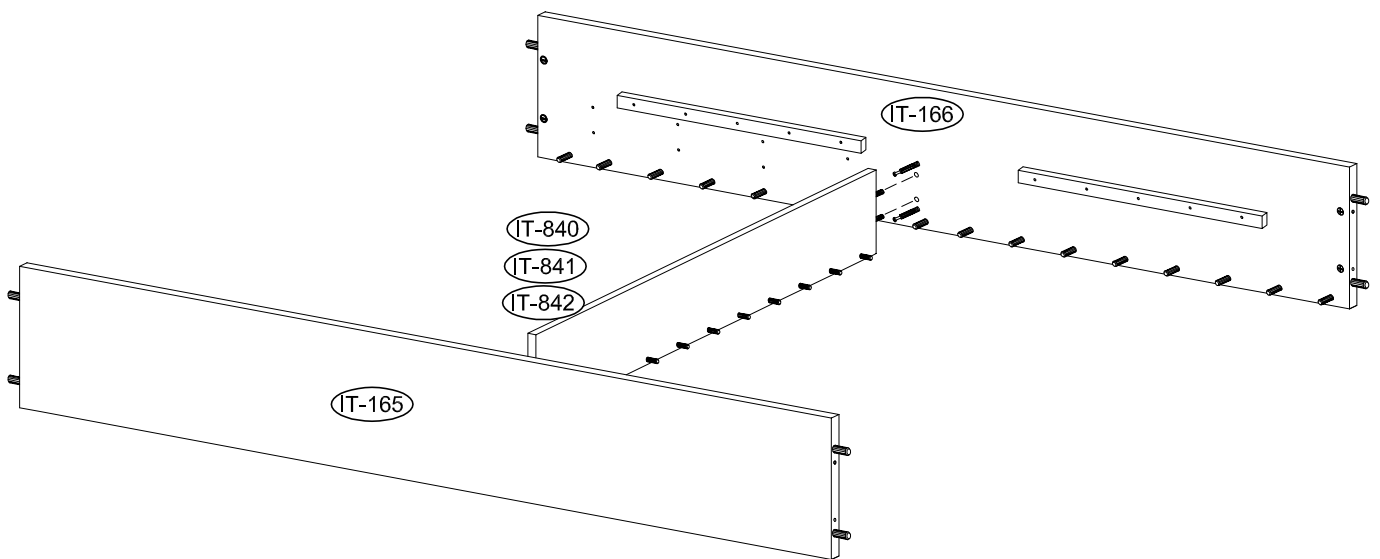

7.

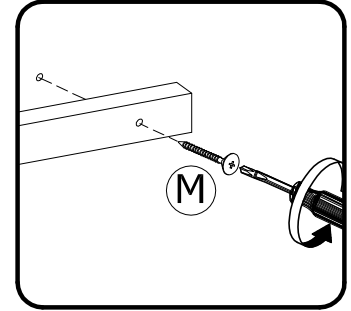
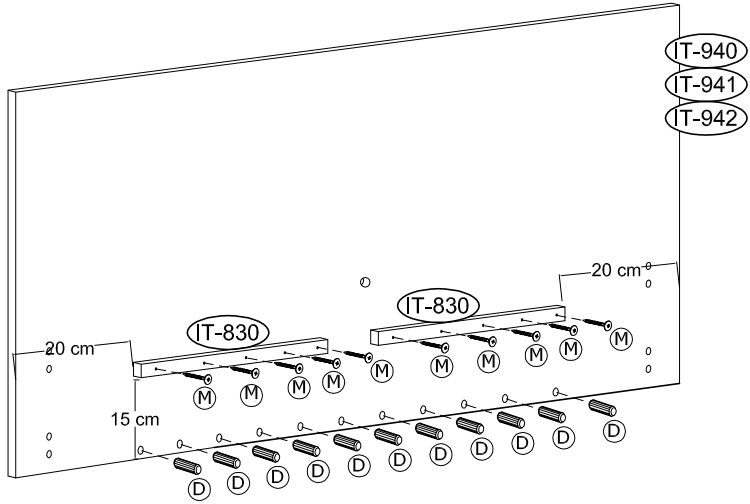
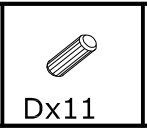
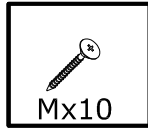

8.

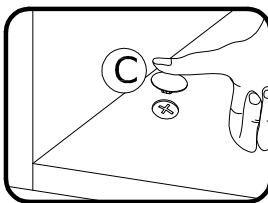
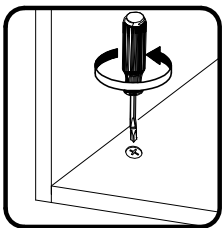
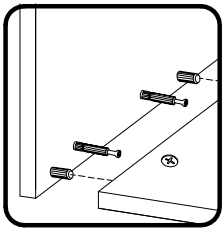
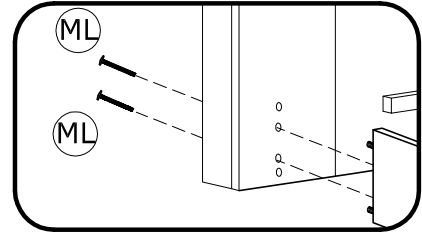
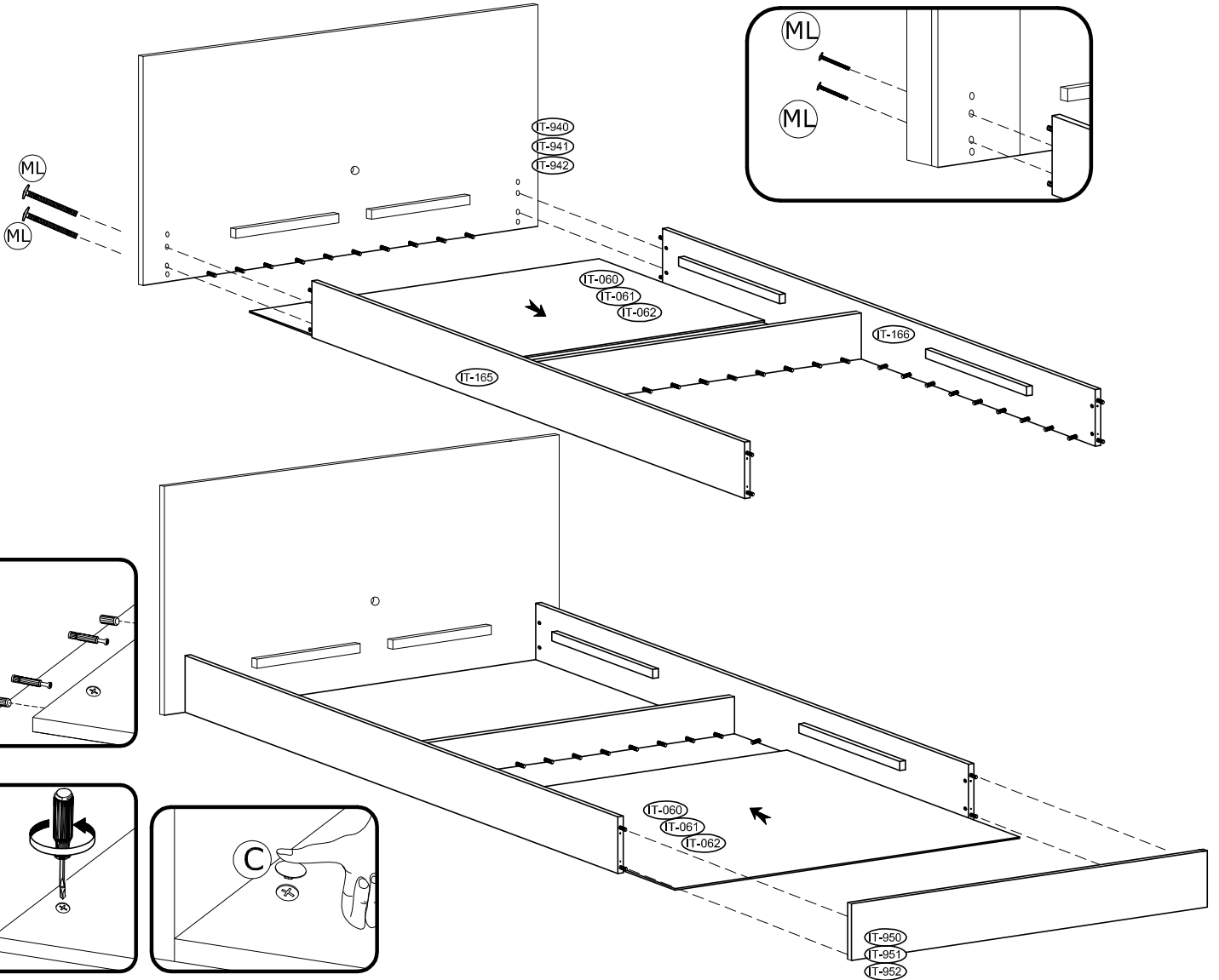
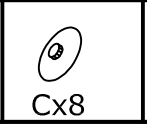
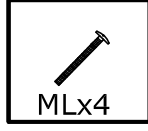

9.



PSx2

